

# PRO- NET

- IT Profilo in alluminio ossidato per incasso** - Tagliabile a misura; si abbina ad uno schermo in policarbonato, anch'esso tagliabile a misura, e a terminali di chiusura (opzionali). Per l'installazione è possibile utilizzare clip di ancoraggio (opzionali).
- EN Oxidized aluminium profile for flush mounting** - Cuttable to size; it combines with a polycarbonate screen, also cuttable to size, and end caps (optional). Installation by means of fixing clips (optional).
- DE Einbauprofil aus eloxiertem Aluminium** - Kürzbar und kombinierbar mit einer kürzbaren Polycarbonat-Abdeckung und Endkappen (optional). Montage mit Befestigungsclips (optional).

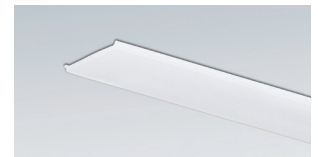

Ⓐ Schermo  
Screen / Abdeckung

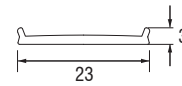
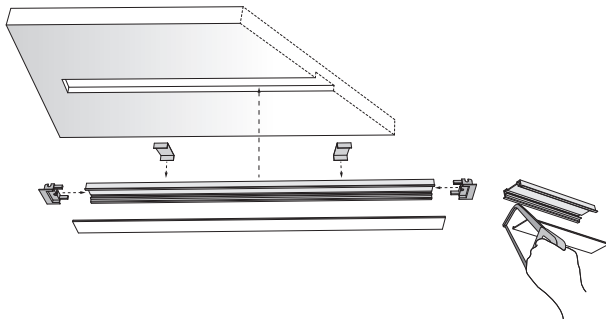
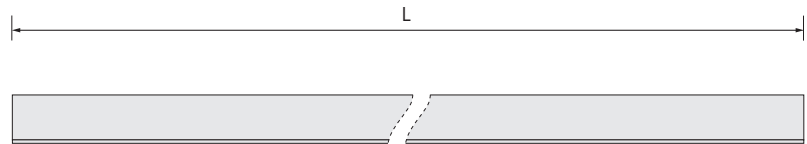
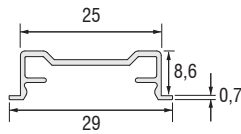
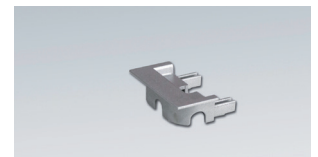
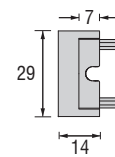

Ⓑ Terminali  
End covers / Endkappen

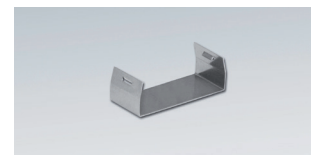
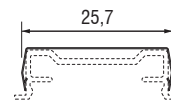

Ⓒ Clip di fissaggio / Fixing clip / Clip

Profilo - Profile - Profil	
L	Codice - Part no. - Artikel-Nr.
2000	668PI2000S
3000	668PI3000S
Schermo - Screen - Abdeckung	
L	Codice - Part no. - Artikel-Nr.
2014	668S2000
3014	668S3000
Terminali - End covers - Endkappen	
PCS	Codice - Part no. - Artikel-Nr.
PAIR	668TI02S
Clip di ancoraggio - Fixing clip - Clip	
PCS	Codice - Part no. - Artikel-Nr.
1	668M001

Dimensioni in millimetri (mm) / Dimensions in Millimeters (mm) / Dimensionen in Millimetern (mm)